



LED LIGHTING SOLUTIONS

Revolutionary Concepts For Shipboard Lighting

LLS360® COMMERCIAL LED FIXTURE



LISTINGS

- UL844 Class I, Division 2 Groups A, B, C & D
- UL1598 Wet/Damp
- UL1598A Marine Grade & ABS
- UL8750 LED Lighting
- UL924 Emergency Battery Backup Available
- IP66
- T4A or Better

WATTAGE, VOLTAGE AND LUMENS

25Watt	120/277VAC	3,500 Lm
35Watt	120/277VAC	5,075 Lm
47Watt	120/277VAC	6,650 Lm

38Watt	347/480VAC	3,500 Lm
47Watt	347/480VAC	5,075 Lm
55Watt	347/480VAC	6,650 Lm

SPECIFICATIONS

- Weight:** Less than 8lbs
- Dimensions:** 11.5 x 13.1875 x 5.075
- CCT:** 4000K Standard (5000K Upon Request)
- Voltage:** 120/277 or 347/480VAC
- Housing:** Die-Cast Aluminum
- Fasteners:** Stainless Steel
- Lens:** Acrylic
- Warranty:** 3 Years

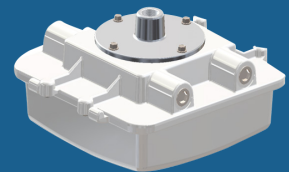
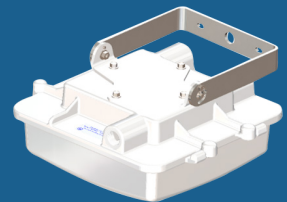

©LEDLIGHTINGSOLUTIONS

DIRECT: karl@karlvolkco.com

OFFICE: 251.621.2663

MOBILE: 251.510.3810

WWW.LEDLIGHTINGSOLUTIONS.COM

All rights reserved. LED Lighting Solutions reserves the right to change specifications for product improvement without prior notice.



LED LIGHTING SOLUTIONS

Revolutionary Concepts For Shipboard Lighting

LLS360 FIXTURE CONFIGURATIONS

LLS360

25	25 Watt (LV Only)	40	4000K	LV	120/277VAC	VM	Vessel Mount	EM	Emergency
35	35 Watt (LV Only)	50	5000K <small>(5000K Upon Request)</small>	HV	347/480VAC	PM	Pendant Mount	*If unit is non-emergency, leave blank	
38	38 Watt (HV Only)					TM	Trunnion Mount		
47	47 Watt (LV & HV)								
55	55 Watt (HV Only)								

CONFIGURATION EXAMPLE

Part No. LLS360-47-40-HV-VM
Description LLS360 LED Fixture, 47Watt, 4000K, 347/480VAC, Vessel Mount

VESSEL MOUNT

PENDANT MOUNT

TRUNNION MOUNT

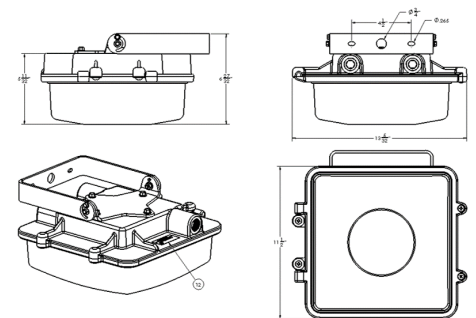
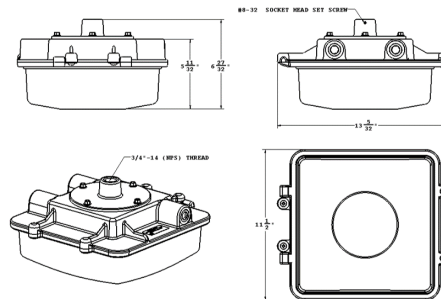
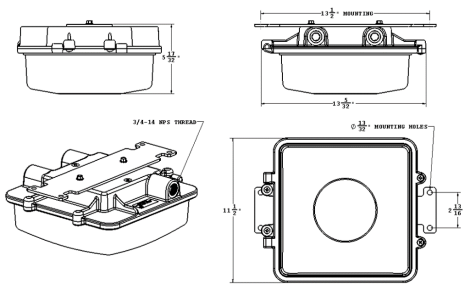



LED LIGHTING SOLUTIONS

Revolutionary Concepts For Shipboard Lighting

REPLACEMENT PARTS

PART NO.

DESCRIPTION

W-100M	LLS360 Cover Window
MNT-009-00	Vessel Mount, HAZLOC, LLS360
MNT-010-00	Pendant Mount, HAZLOC, LLS360
MNT-012-00	Trunnion Mount, HAZLOC, LLS360
LLS-PC-0018-00	LED Array, White, HAZLOC, LLS360
D-H360-01-25	LED Driver, 25Watt, 700mA, HAZLOC, LLS360
D-H360-01-40	LED Driver, 40Watt, 1050mA, HAZLOC, LLS360
D-H360-02-40	LED Driver, 40Watt, 1400mA, HAZLOC, LLS360
TRF-H01-01	Transformer 35VA, 480VAC
TRF-H01-02	Transformer 75VA, 480VAC

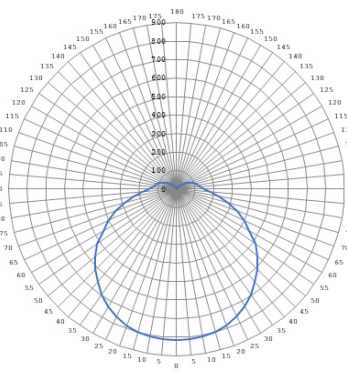

LLS360-25-40-LV-XX

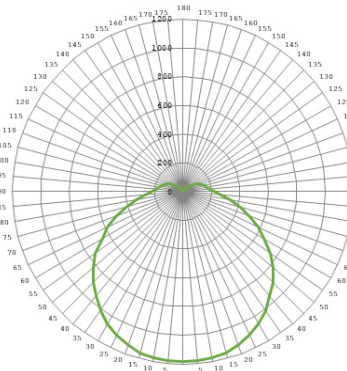

LLS360-35-40-LV-XX

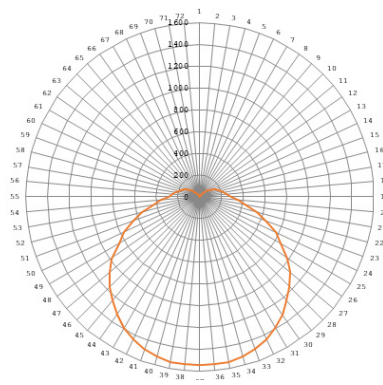

LLS360-47-40-LV-XX